



Edge 8300

Intelligent Edge™ – Multi-Service Edge Router & SBC



High quality bandwidth is the lifeblood of business, especially as organizations move business applications to the cloud. Collaboration, streaming video, data storage, and data back-up services all require greater bandwidth to operate effectively.



Service providers and business customers need an Intelligent Edge device that cost effectively delivers, manages, protects, and monitors high-capacity broadband connections, offering superior performance and value.

Ribbon's Edge 8300 delivers superior value by offering a common platform that includes:

- A high performance, full-featured, multi-tenant, data router with up to 10 Gbps of throughput
- Market leading Session Border Controller (SBC) services to protect communications traffic
- Analog line and station port, (FXO/FXS) and PRI port connectivity options
- High Availability (HA) option for SBC services and integration with Microsoft Teams Survivable Branch Appliance (SBA)
- Multiple hardware choices for cost effective and highly resilient deployment requirements

Given that most business applications, including communications, are cloud based, data performance is more critical than ever. Yet, many mid-size businesses and multi-site enterprises struggle to find a routing platform that's robust enough to deliver their mission critical business applications and still cost effective to meet their budget. Too often organizations are forced to choose between consumer-grade solutions that are not robust or industrial-grade solutions that are over-priced.

Ribbon's Edge 8300 is different. It offers 2.5, 5, or 10 Gbps of routing throughput, with Session Border Control (SBC), gateway and high availability options, all in one intelligent edge device. It leverages Ribbon's proven SBC SWe Edge software to assure security. And, with more than a million edge elements deployed globally, Ribbon understands how to build and deliver reliable, secure solutions.

The Edge 8300 is also designed for what comes next. It includes VNF (Virtual Network Function) support to deliver uCPE-based services (centrally managed and strategically located at the edge of a customer's network) to run additional services. Service

Key Capabilities

- Robust routing with data rates of up to 10 Gbps
- Multihoming with BGP for resilient/diverse links
- Large scale NAT support for multi-tenant use
- All physical interfaces (10 ports) can be provisioned as WAN or LAN (No fixed function for interfaces)
- SBC capacity of up to 900 concurrent calls - optional HA



Certified for Popular Cloud Solutions

Key Connectivity Choices for Edge 8300

Maximum Data Throughput	10 Gb
Maximum Concurrent Calls	900
Maximum VLANs	100
SFP+ Ports 10Gb (requires SFP+ transceivers)	2
Ethernet Ports 10/100/1000	8
FXO/FXS/PRI Port Maximums	2/24/4
AC Power Options	Single or Dual
DC Power Option	Dual



Telecom Connectivity – Analog and Digital Ports



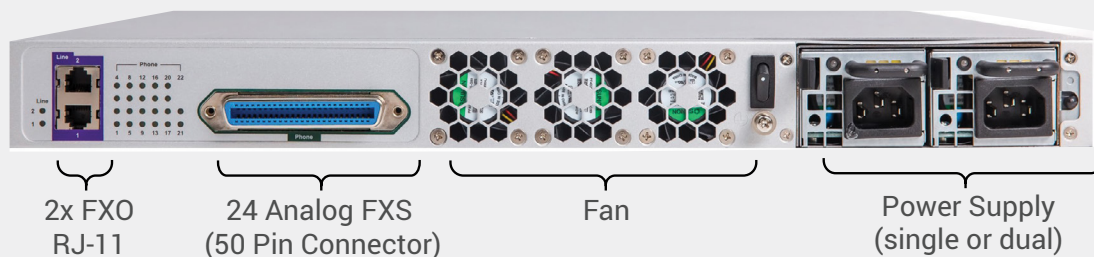
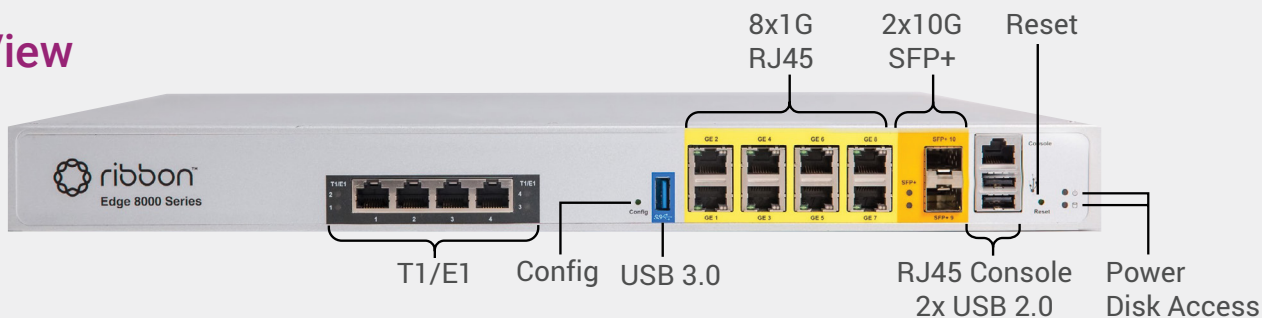

Across the globe traditional PSTN services are being discontinued and/or prices are being increased on traditional analog or PRI-based services to encourage organizations to migrate to IP-based connectivity. While this makes sense strategically, it doesn't address the tens of millions of traditional devices (elevator phones, paging systems, alarm systems, door phones, etc.) that need to be maintained. Not to mention the need to replace traditional PBXs if they don't support SIP Trunks.

Ribbon's Edge 8300 offers an ideal solution. It offers up to four T1/E1 ports as well as options for up to 2 analog line ports (FXO) and up to 24 analog station ports (FXS). Multi-site organizations and service providers can use the Edge 8300 as "Swiss Army Knife", deploying it in a wide variety of settings to handle routing, telecom security and interoperability across both IP-based and legacy telecom devices. Organizations can configure different sites for different capacities and different connectivity requirements, while maintaining a consistent edge device across hundreds or thousands of locations. The Edge 8300 delivers outstanding value by incorporating multiple solutions in a single 1U chassis. It also reduces total cost of ownership by providing remote access to a common set of services and trouble shooting tools.

Front View



Rear View

Multiple Configuration Options	
 Routing	1Gb, 5Gb or 10 Gb router
 Session Border Control	Licensed in quantities of 5 sessions, up to 900
 T1/E1	4 PRI ports included
 FXO/FXS	2/22 or 0/24 ports
 Power	Single AC, dual AC or dual DC

Multi-tenant Bandwidth Aggregation – Use case



High Performance SBC – Use case



Branch Office – Use case

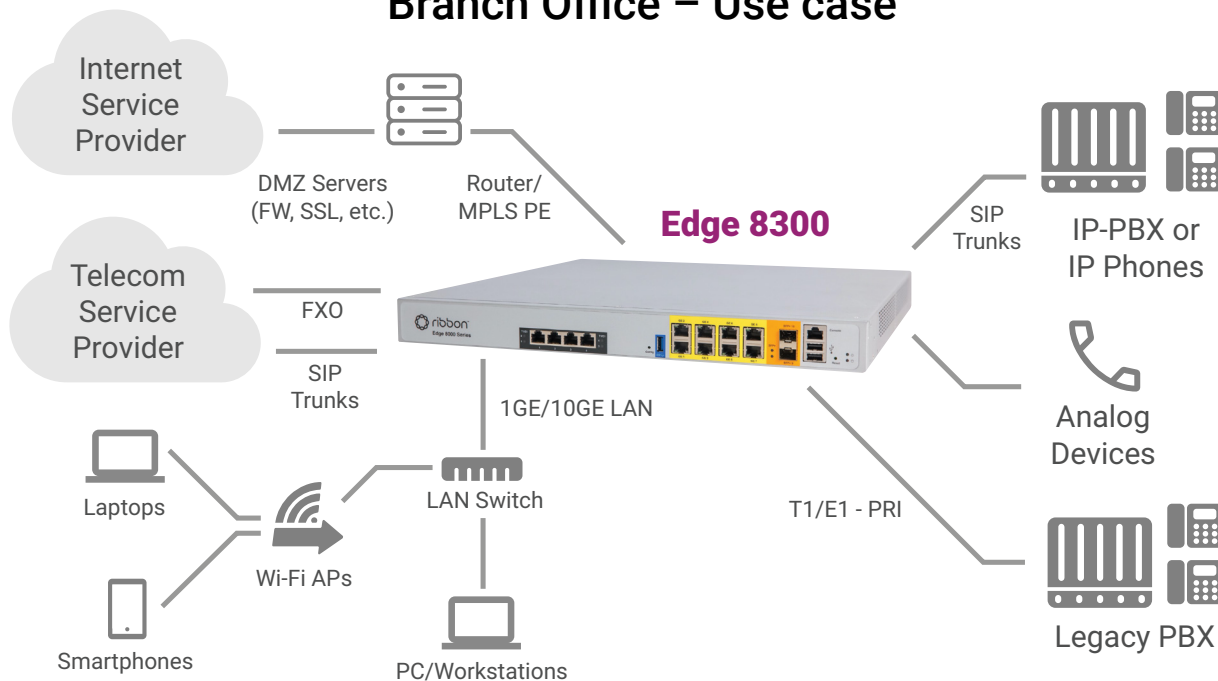

Features and Capabilities	Specifications
Maximum data throughput	10 Gbps
Maximum number of registered devices (SIP endpoints)	5000
Maximum concurrent voice sessions (SIP sessions)	900
Telecom Ports	
Maximum FXO Ports	Up to 2, RJ-11
Maximum FXS Ports	Up to 24, 50 pin telco connector – 1000 ft maximum loop length, 5 REN
Maximum PRI Ports (T1/E1)	4x RJ-48
Data Ports	
Fiber 10G	2x SFP+ interface
LAN/NIC	8x 1Gbps, RJ-45, support SR-IOV
Management Interfaces	
USB	2x USB 2.0 Front Type-A & 1x USB 3.0 Type-A
Security	
Encryption and Authentication	TLS, SRTP, HTTPS, SSH
Encryption protocols supported	3DES, AES, SHA-256, MD5
System Management	
Local Device Management	CLI (SSH) NETCONF
Remote upgrades, back-up, restore	FTP, HTTP/S
Firmware	Local firmware image for upgrade
Network Management	SNMPv1-3
Message Analytics	System monitoring and SIP statistics
Debug tools	Packet capture (tcpdump), traceroute, ping, syslog
Hardware Specifications	
Dimensions (L x W x H)	44mm (1.73", 1U)H x 445mm (17.5")W x 437.8mm (17.23")D
Weight	4.1 kg (9 lbs) - Single PSU
Mounting Options	Shelf, Rack Mountable
Operating Temperature	0-40 deg. Celsius with 3 variable speed fans
Operating Relative Humidity	4% to 90% (non-condensing)
Compliance	RoHS 2.0, UL/cUL, CB, FCC part 15, FCC part 68, IC, CE, RCM and VCCI
Power	Single PSU 250W 110-240 VAC, 50-60 Hz. Optional dual 300W AC or 48V DC Power Supply
Hardware Warranty	1 year
Certifications	UL, FCC-15, FCC-68

Features and Capabilities	Specifications
Routing Services	
Network Throughput Options (bi-directional - offload throughput for UDP/TCP/GRE)	<ul style="list-style-type: none"> • 2.5G • 5G • 10G
Routing Protocol Support	<ul style="list-style-type: none"> • BGP4, BGP4+, BGP RPKI, BGP L3VPN • OSPFv2, OSPFv3 • RIPv1, RIPv2, RIPng • Static Routes • Path Monitoring for Static Routes • ECMP • PBR • MPLS • BFD • NHRP • VXLAN EVPN
L2 and Encapsulation	<ul style="list-style-type: none"> • VLAN (802.1Q QinQ) • VXLAN • LAG (802.3ad, LACP) • Ethernet Bridge
IP Networking	<ul style="list-style-type: none"> • IPV6 Autoconfiguration • VRF • NAT • Multicast
Management & Monitoring Options	<ul style="list-style-type: none"> • SSHv2 • CLI • NETCONF/ YANG • REST • SNMP • Syslogs • 802.1ab LLDP
Security	<ul style="list-style-type: none"> • ACLs
IP Services	<ul style="list-style-type: none"> • DHCP Server/ Client/ Relay • DNS Client/ Proxy • NTP
QoS Services	<ul style="list-style-type: none"> • Rate Limiting per Interface • Rate Limiting per VRF • Class-based QoS • Classifications: ToS/ IP/ DSCP/ CoS • Shaping and Policing
	<ul style="list-style-type: none"> • Scheduling: PQ, PB-DWRR, HTB
Logging Options	<ul style="list-style-type: none"> • Port batching • Syslog
ALG Support	<ul style="list-style-type: none"> • FTP • TFTP • PPTP
Additional Services	<ul style="list-style-type: none"> • Endpoint-Independent Mapping and Filtering • Address and Port-Dependent Mapping and Filtering
Traffic Prioritization & QoS	<ul style="list-style-type: none"> • Class-based QoS • Classification: ToS / IP / DSCP / CoS • Shaping and Policing • Scheduling: PQ, PB-DWRR, HTB
DHCP	<ul style="list-style-type: none"> • Server/ Client/ Relay
VLANs	<ul style="list-style-type: none"> • 802.1Q (up to 100)

Features and Capabilities	Specifications
SBC Services	
Security	<ul style="list-style-type: none"> • TLS (Transaction Layer Security) for signaling encryption - TLS 1.2 (RFC 5246) • Secure Real-time Transport Protocol (SRTP) & Control Protocol (SRTCP) for media and media control encryption (RFC 3711) • Multiple unique X.509 public key certificates/PKCS #12 files (up to 11) • Wildcard certificate support • Topology hiding; user privacy • Prevention of Denial-of-Service (DoS) and Distributed DoS (DDoS) attacks • Traffic separation (VLAN interface separation) • Malformed packet protection • Access Control Lists (ACLs) • IPsec VPN tunnel • NAT/NAPT and port forwarding; NAT traversal
Protocol Support	<ul style="list-style-type: none"> • SIP (RFC 3261) over UDP, TCP, TLS • RTP/RTCP/RTCP-XR (RFC 3550, 3551, 3611) • RTP/RTCP multiplexing over single UDP port (RFC 5761) • IPv4, IPv6, and IPv4/IPv6 interworking • DHCP server & client (RFC 2131) • Network Address Translation – NAT (RFC 2663) • SNMPv2c, SNMPv3 • HTTPS
Media Services	<ul style="list-style-type: none"> • G.711, G.722, G.722.2 (AMR-WB), G.723.1, G.726 (32 kbps), G.729A/B (8 kbps), T.38, SILK-NB/WB media encoding • Video interworking • Session Recording Protocol support - SIPREC (RFC 7866) • DTMF support: RFC 4733, inband DTMF, SIP INFO (RFC 2833) • Voice Activity Detection (VAD) • G.168 Echo cancellation with standard 128 ms tail length • Comfort noise generation and packet loss concealment • Music on hold • RTP inactivity monitoring (inactive call detection)
Quality of Service (QoS)	<ul style="list-style-type: none"> • Bandwidth management • Call Admission Control (CAC) to deny inappropriate calls • P-time mediation for rate limiting • Per-call statistics • Diffserv/DSCP marking
Routing/Policy	<ul style="list-style-type: none"> • Interactive Connectivity Establishment (ICE), lite support (RFC 8445) • Active Directory®/LDAP-based call routing • Least cost, time of day and quality-based routing • On-board call forking (up to eight end points) • Supplementary services: call hold, call transfer (blind & assisted) and call forward • SIP routing based on source and destination IP address or Fully Qualified Domain Name (FQDN) • ITSP E911 support; 911 call preemption
Management Capabilities	<ul style="list-style-type: none"> • Single, secure, web-based GUI with real-time port monitoring • Easy Configuration Wizard, for quick provisioning between SIP trunks, SIP phones, SIP PBXs (e.g. Avaya® Aura® or Cisco® Unified Communications Manager, Microsoft Direct Routing) • Centralized management from Ribbon Application Management Platform (RAMP) • REST-based programmatic interface to remotely manage multiple SBCs • SNMP v2c/v3 for comprehensive network management using third-party management systems • Configuration backup and restore; upload from one site to another • CDR reporting and local logging for troubleshooting • Free Ribbon LX syslog server and log parser tool available • Authentication: local user (username/password), Active Directory®, RADIUS
Certified SBC for Microsoft Phone System & Direct Routing (Teams)	<ul style="list-style-type: none"> • Supports integration with Teams Survivable Branch Appliance (SBA) • SILK-NB, SILK-WB codec support for improved Microsoft Teams user experience • Enhanced 911 (E911) and Emergency Location Identification Number (ELIN) Gateway Support • Media Bypass and Local Media Optimization support • Simplified migration from on-premises Skype for Business Server to Microsoft Teams • Support for multiple tenant-related Direct Routing deployments with Microsoft partners/PSTN carriers

Features and Capabilities	Specifications
SBC Services	
Site Survivability	<ul style="list-style-type: none"> • Supports high-availability deployment of SBC SWe Edge • IP route redundancy to UC provider, in case of ISP or router failure • PSTN fallback in case of WAN failure • Built-in SIP registrar for site survivability for SIP clients including Yealink® Teams and Poly® UC phones and conference bridges • Multiple Spanning Tree Protocol, to prevent routing loops



We are here to help. Contact us about our Edge solutions.

About Ribbon

Ribbon Communications (Nasdaq: RBBN) delivers communications software, IP and optical networking solutions to service providers, enterprises and critical infrastructure sectors globally. We engage deeply with our customers, helping them modernize their networks for improved competitive positioning and business outcomes in today's smart, always-on and data-hungry world. Our innovative, end-to-end solutions portfolio delivers unparalleled scale, performance, and agility, including core to edge software-centric solutions, cloud-native offers, leading-edge security and analytics tools, along with IP and optical networking solutions for 5G. We maintain a keen focus on our commitments to Environmental, Social and Governance (ESG) matters, offering an annual Sustainability Report to our stakeholders. To learn more about Ribbon, please visit rbbn.com.